



MasterRents

Address
46 Prince St
Danvers, MA 01923

Phone
978-762-RENT (7368)

84in 12 Ton Roller Compactor Dimension Sheet

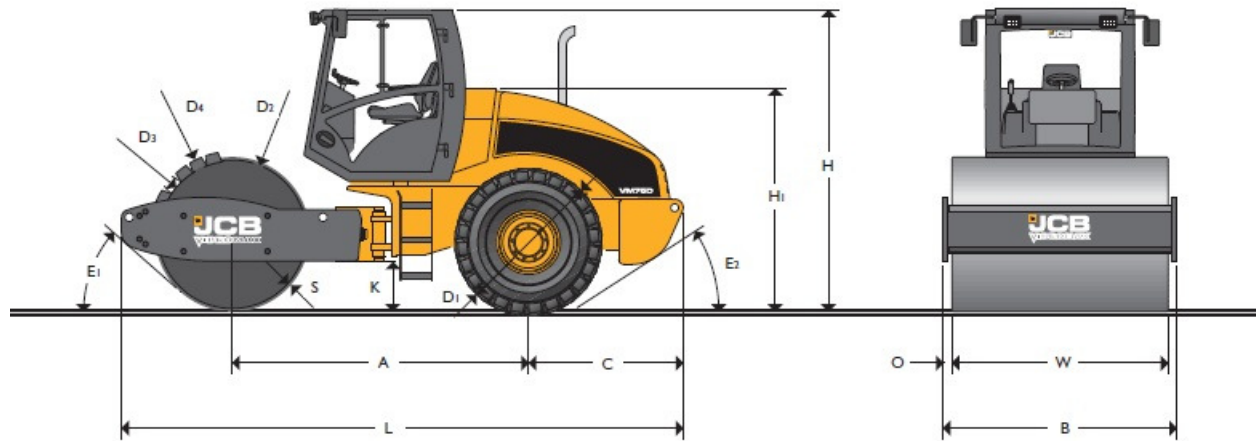

STATIC DIMENSIONS

Dimensions in millimetres (in)		
A	Wheelbase	2514 (99.0)
B	Overall width	1870 (73.6)
C	Axle to rear face	1470 (57.9)
D1	Wheel diameter	1298 (51.1)
D2	Drum diameter (smooth drum)	1220 (48.0)
D3	Inner diameter padfoot drum	1140 (44.9)
D4	Outer diameter padfoot drum	1300 (51.2)
H	Total travel clearance	2845 (112.0)
H1	Height to top of seat	2070 (81.5)
K	Ground clearance	389 (15.3)
L	Total travel length	4887 (192.4)
O	Overhang	60 (2.4)
S	Drum thickness	25 (1.0)
W	Drum width	1750 (68.9)
E1	Front departure angle	40°
E2	Rear departure angle	28°